

Aluminum Fan Filter Assembly

AFK-92

92_{mm}

FAN ACCESSORIES

TECHNICAL OVERVIEW

Part Number.....AFK-92

MaterialAluminum/Stainless Steel

Screen30 x 30 mesh convoluted
with 3/16" pitch, 1/8" deep

FinishMill and Anodized

Innovative design for efficient
filtering and shielding

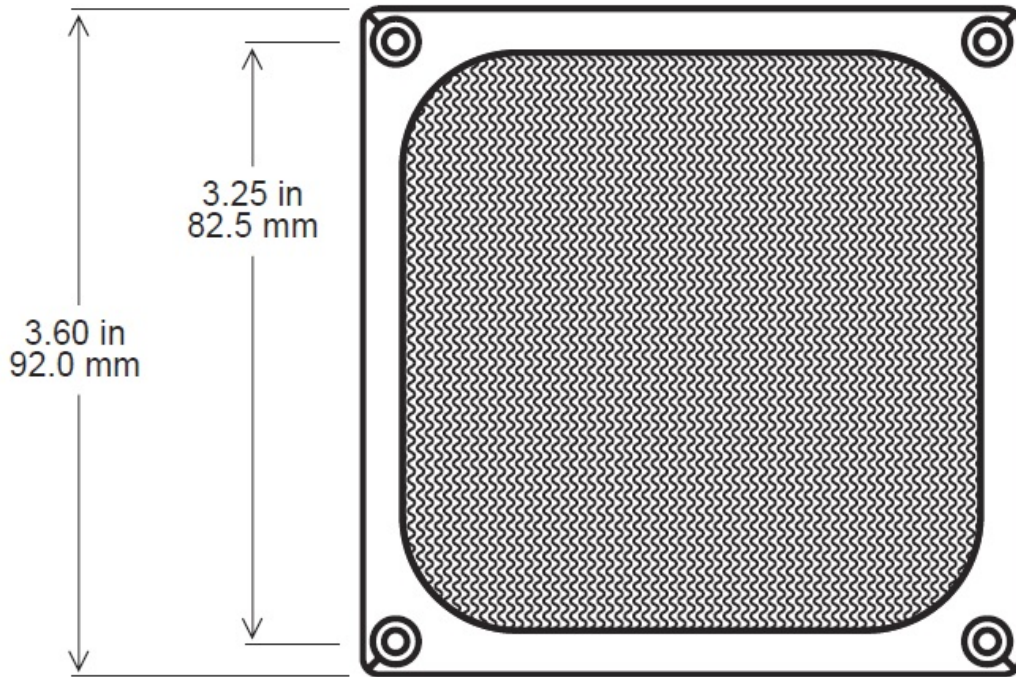

0.17 in
4.3 mm
Mounting Hole Dia.

