

JH160 Inline Duct Fan

160mm (6.3in)



GENERAL SPECIFICATIONS



- Impeller:** PA66+25%GF
- Housing:** SGCD2
- Life:** 30,000 hours
- IP Rating:** IP44
- Operating Temp:** -40°C~+80°C
- Wire:** 20 AWG

FEATURES

- High efficiency inlet design
- Whisper-quiet performance
- Lubricated sealed ball bearings
- External rotor motor w/backward-curved centrifugal fan
- Includes housing, impeller, motor, base, and ABS connection box

MODEL	VOLTAGE (V)	FREQ (Hz)	CURRENT (A)	POWER (W)	SPEED (RPM)	AIR FLOW (m ³ /h)	AIR FLOW (CFM)	PRESSURE (Pa)	NOISE (dBA)	INSULATION CLASS
JH160A	240	50	0.29	72	2500	460	271	352	46	F
JH160B	240	50	0.92	112	2985	695	409	389	50	F

Performance Curves

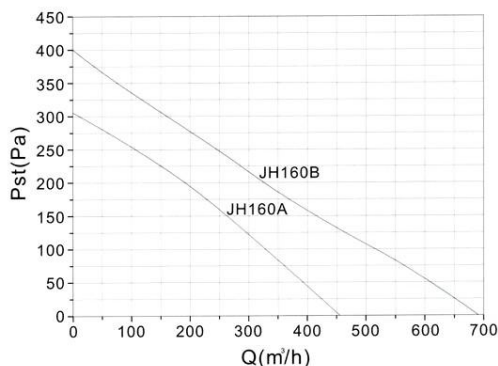

Dimensions

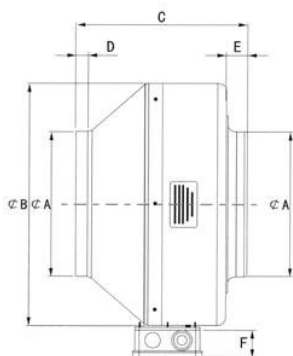

Wiring Diagram

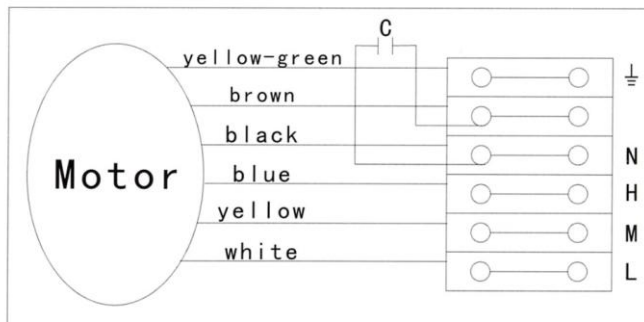

	A	B	C	D	E	F
JH160A/B	160	278	195	25	25	42

Note: All dimensions in mm

Applications

Commercial and industrial applications, condominiums, apartments, hospitals, hotels, and other areas with limited space.



T 1.888.546.0524 • F 1.610.647.0319
 email: sales@pelonistech.com • www.pelonistech.com

