

DC Backward Curve Motorized Impeller

R1D175 Centrifugal Fan

175mm (6.9in)

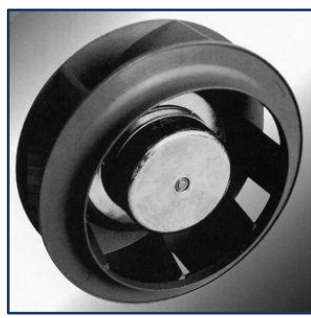

GENERAL SPECIFICATIONS

- Impeller:** PA66+20%GF
- Life:** 40,000 hours
- IP Rating:** IP42
- Operating Temp:** -20°C~+60°C
- Lead Wires:** 20 AWG

FEATURES

- High efficiency inlet design
- Lubricated maintenance-free ball bearings
- Vibration-free operation
- Precision balanced for superior performance
- Compact and rugged construction

model	bearings (V)	voltage (V)	range (VDC)	power (W)	speed (RPM)	airflow (m ³ /h)	airflow (CFM)	pressure (Pa)	max ambient temp (°C)	noise (dBA)
R1D175-AB	Ball	24	16 to 28	34	3100	500	294	400	60	65
R1D175-AA	Ball	48	36 to 57	34	3100	500	294	400	60	65

Performance Curves

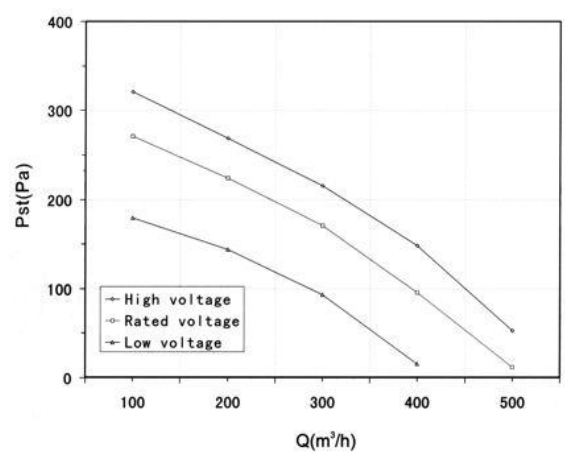

Dimensions (mm)

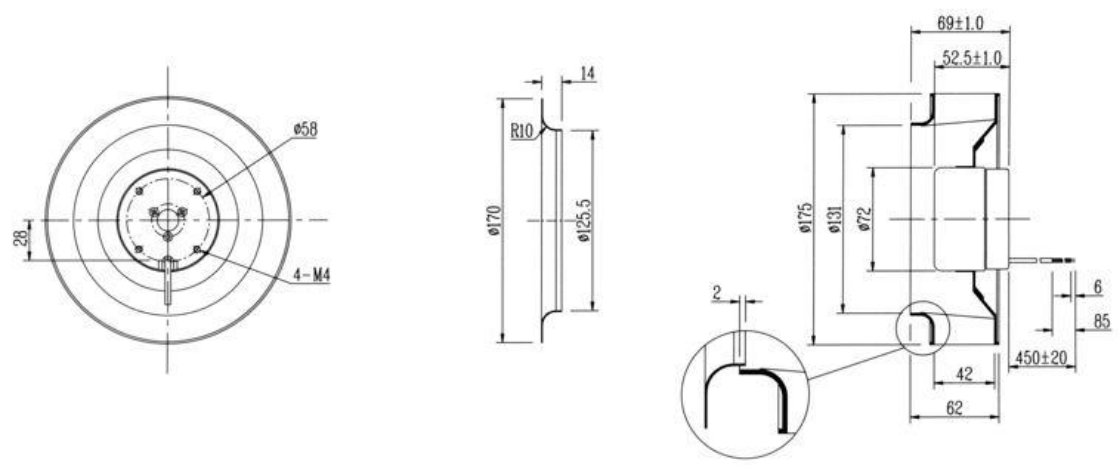

Applications

HVAC, cabinet cooling, medical equipment, military applications, air filtration, semiconductors, commercial and industrial cooling.



T 1.888.546.0524 • F 1.610.647.0319
 email: sales@pelonistech.com • www.pelonistechnologies.com

